

INFINITY

SUSPENDED / SUSPensa / SUSPENDU / SUSPENDIDA

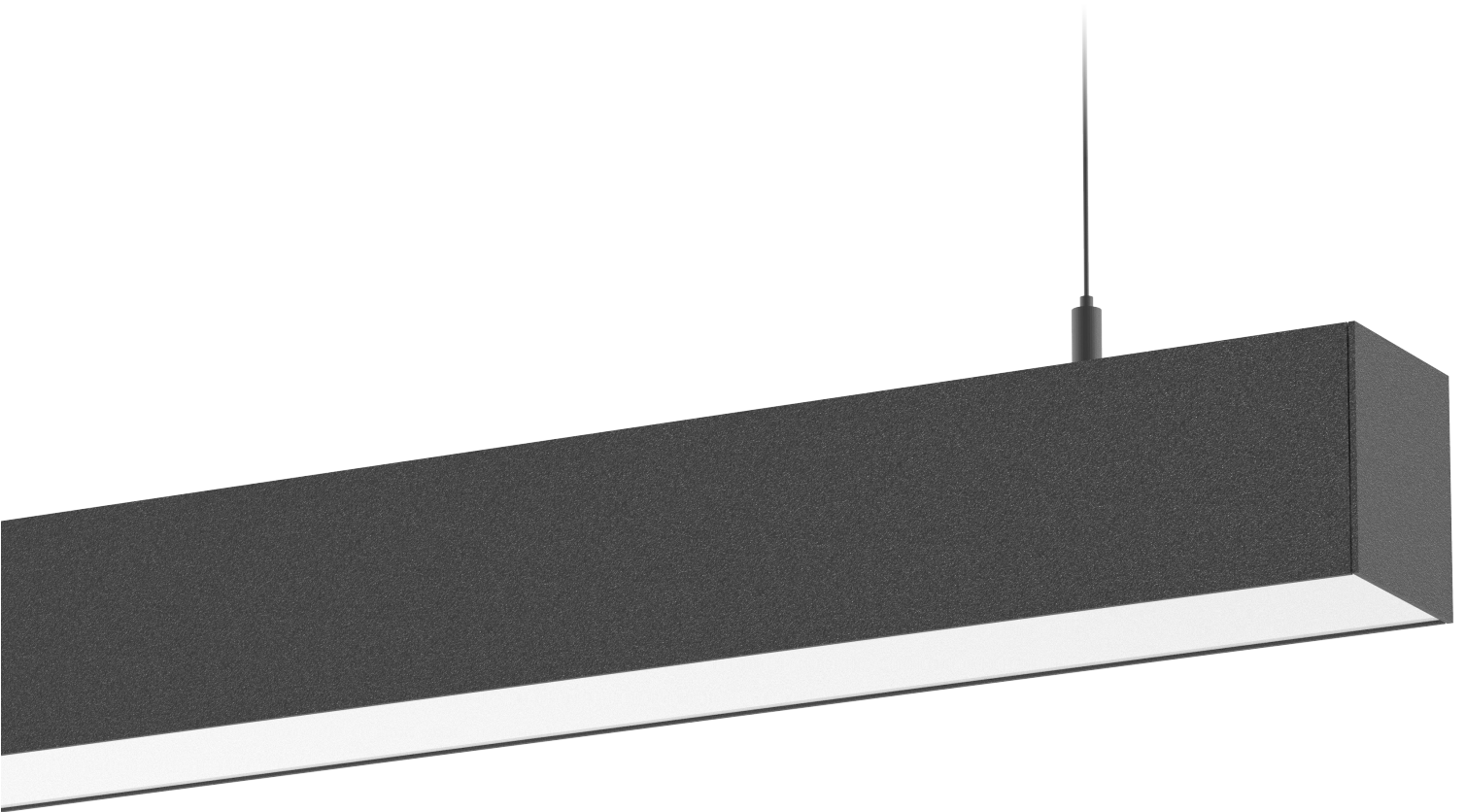

The light sources contained in this luminaire must only be replaced by the manufacturer, its maintenance service or technicians with equivalent qualifications.
Terminal block not included. Installation must be carried out by a qualified person.

As fontes luminosas contidas nesta luminária devem ser apenas substituídas pelo fabricante, pelo seu serviço de manutenção ou por técnicos com qualificação equivalente.
Bloco de terminais não incluído. A instalação deve ser efetuada por uma pessoa qualificada.

Les sources lumineuses contenues dans ce luminaire ne doivent être remplacées que par le fabricant, son service d'entretien ou des techniciens ayant des qualifications équivalentes.
Le bornier n'est pas fourni. L'installation doit être effectuée par une personne qualifiée.

Las fuentes luminosas contenidas en esta luminaria sólo deben ser sustituidas por el fabricante, su servicio de mantenimiento o técnicos con cualificación equivalente.
Bloque de terminales no incluido. La instalación debe realizarla una persona cualificada.

All information in this document is subject to change without notice. / Todas as informações disponibilizadas neste documento podem ser alteradas sem prévio aviso. /
Toutes les informations contenues dans ce document sont susceptibles d'être modifiées sans préavis. / Toda la información disponible en este documento está sujeta a cambios sin previo aviso.

MOD. 071

INFINITY

INSTRUÇÕES DE MONTAGEM · INSTRUCTIONS D'INSTALLATION · INSTRUCCIONES DE MONTAJE

SUSPENDED / SUSPENSA / SUSPENDU / SUSPENDIDA

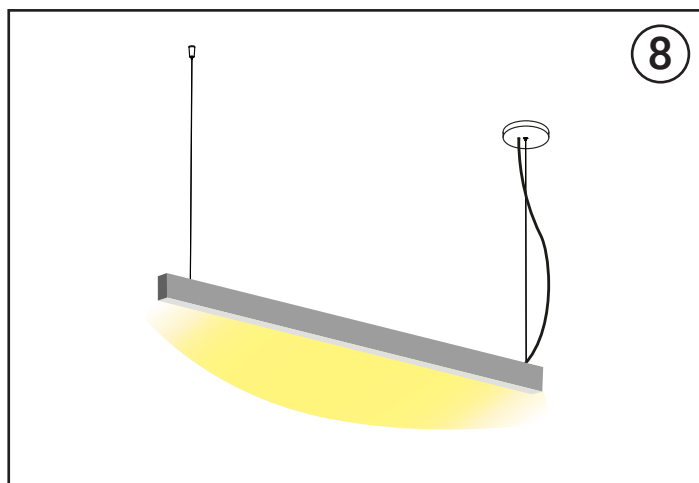
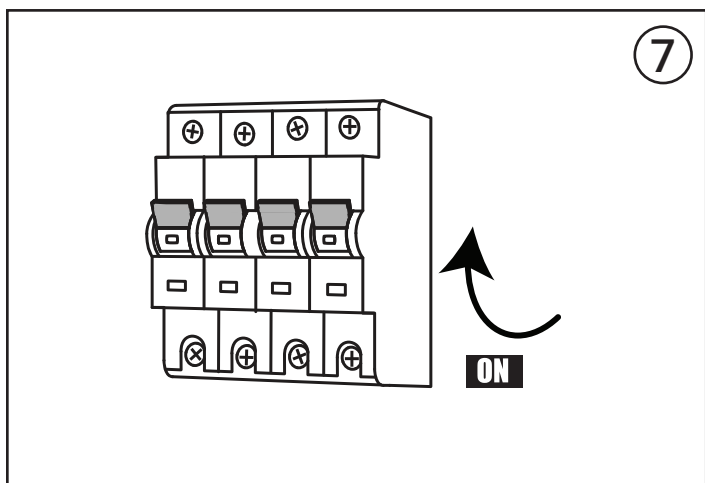
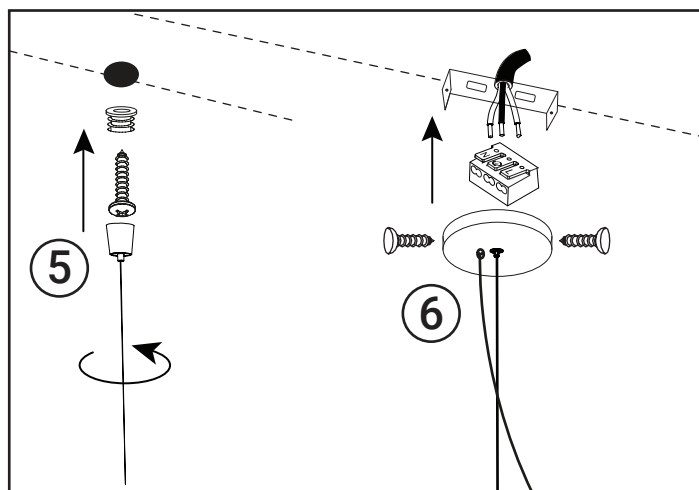
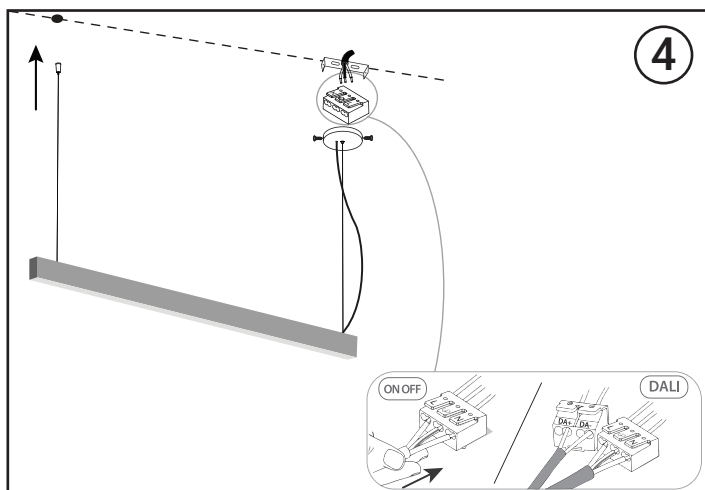
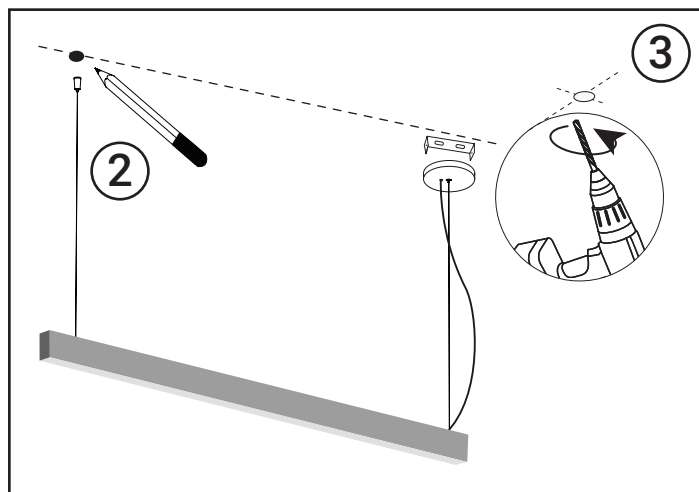
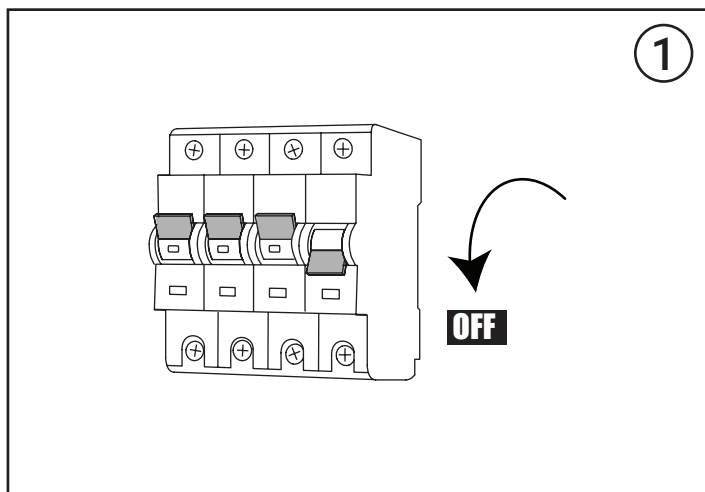

All information in this document is subject to change without notice. / Todas as informações disponibilizadas neste documento podem ser alteradas sem prévio aviso. / Toutes les informations contenues dans ce document sont susceptibles d'être modifiées sans préavis. / Toda la información disponible en este documento está sujeta a cambios sin previo aviso.

Mod. 071

INFINITY

INSTRUÇÕES DE MONTAGEM · INSTRUCTIONS D'INSTALLATION · INSTRUCCIONES DE MONTAJE

SUSPENDED / SUSPENSA / SUSPENDU / SUSPENDIDA

CONNECTION ACCESSORIES / ACESSÓRIOS DE LIGAÇÃO / ACCESSOIRES DE CONNEXION / ACCESORIOS DE CONEXION

